

# Narysować wykresy N, T, M.

## Zadanie 1

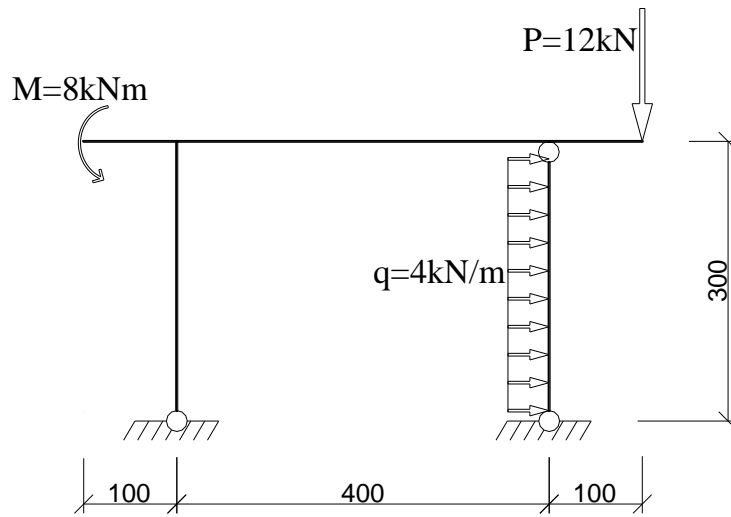

## Zadanie 2

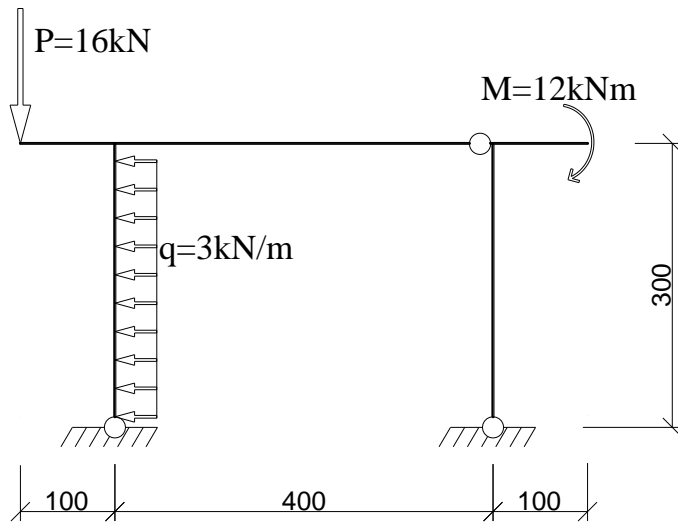

### Zadanie 3

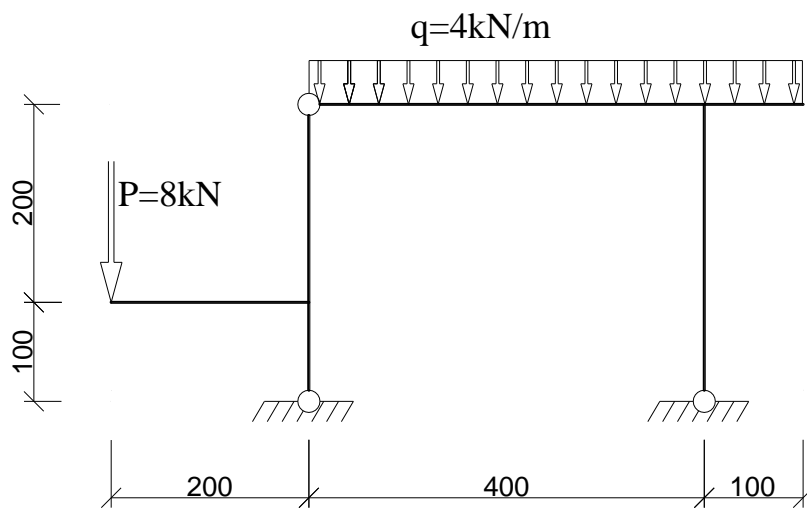

### Zadanie 4

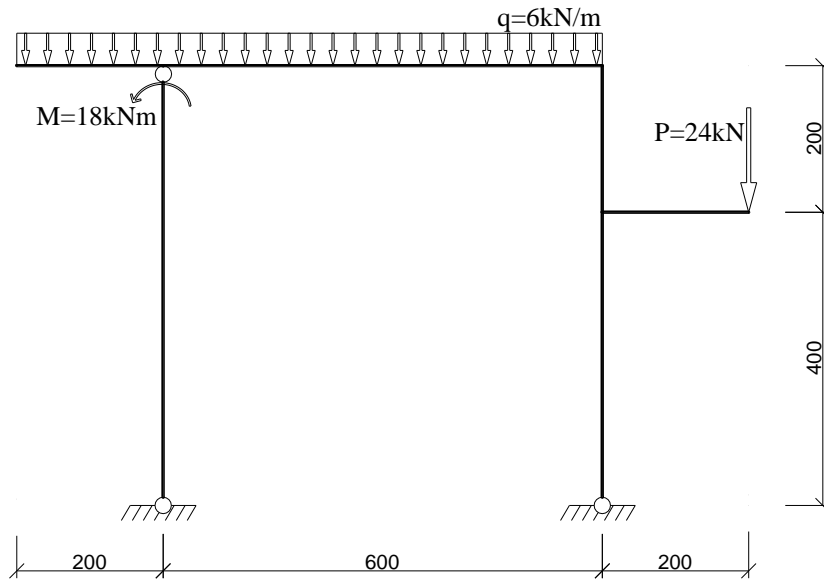

### Zadanie 5

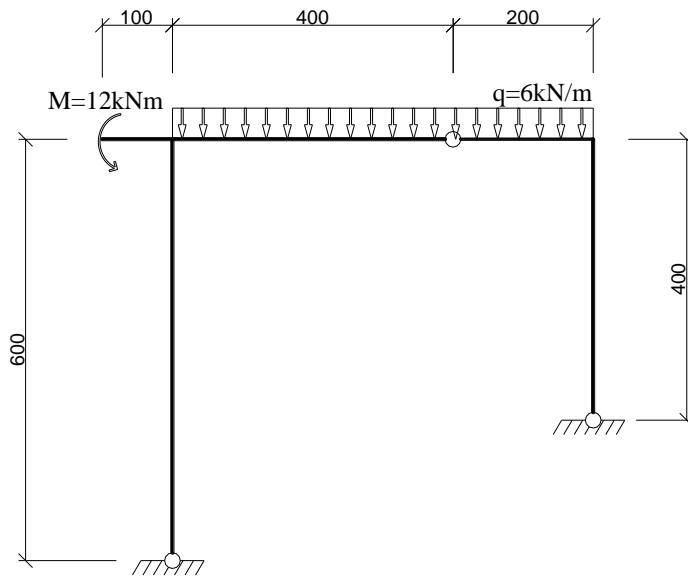

### Zadanie 6

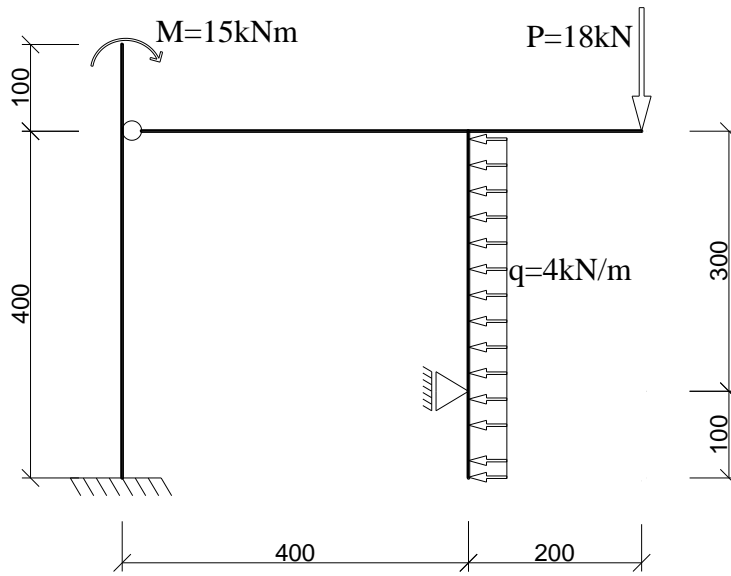

### Zadanie 7

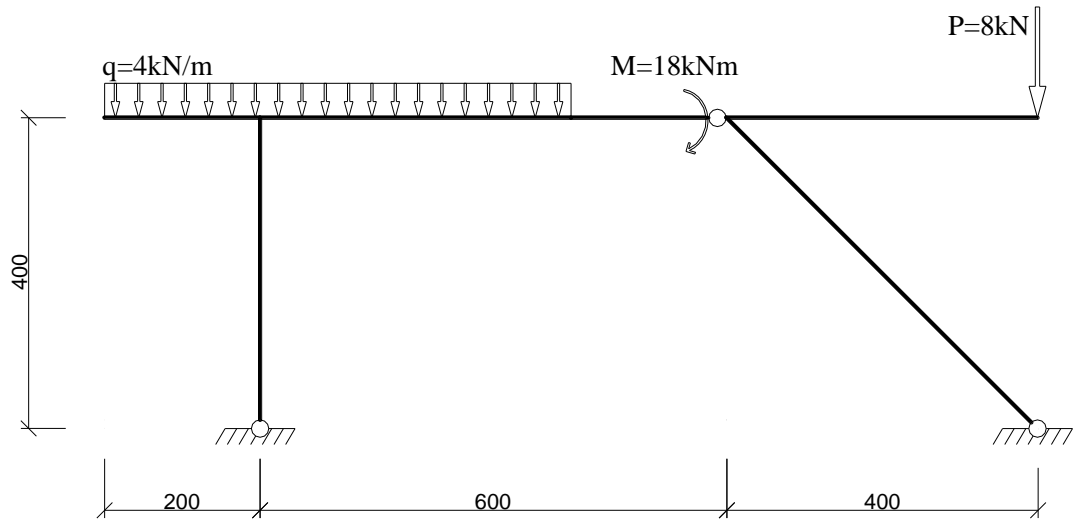

### Zadanie 8

